

# LOW LEVEL TRACE ANALYSIS WORK STATIONS

The Microzone Metal Free Work Stations are for use in areas of the laboratory where samples or processes must be isolated within an ultra-clean "Metal-Free" environment.



Ultra-Clean Metal Free Systems

# LOW LEVEL TRACE ANALYSIS Work Stations

## General

Trace metal clean laboratories are normally physically isolated from the sources of contamination that are so common in regular laboratories. These include cements, paints, metals, and regular plastics that contain relatively high concentrations of metals that are mobilized by the natural degradation of the material. Surfaces that may contaminate a sample should be constructed of relatively clean, inert materials like polypropylene, polyethylene, and teflon. In addition, laminar flow work stations, acid hoods, and casework should be constructed from compatible materials. At Microzone we offer complete low level trace analysis solutions such as Vertical Laminar Flow Fully Exhausted Work Stations, Horizontal Laminar Flow Acid Hoods, Isolated Downflow Ultra-Clean Enclosures, Perchloric Fume Hoods, Casework, Chemical Handling/Storage Cabinets, and Custom Enclosures.



CUSTOM UNITS



ACID STORAGE CABINETS



FUME HOODS



VERTICAL LAMINAR FLOW  
WORK STATIONS



HORIZONTAL LAMINAR  
FLOW ACID HOODS



PLASTIC CASEWORK



PERCHLORIC HOODS

# VERTICAL LAMINAR FLOW

## Fully Exhausted Polypropylene Type W

### General Features

- Exterior shell constructed from all-welded white 1/2" polypropylene.
- Interior work volume constructed from white 1/2" polypropylene, with a sectional work deck constructed from 1/2" polypropylene with integral perforated front intake grille at work surface level.
- Faceshield constructed from clear P.V.C. There are no exposed cables or counterbalancing mechanisms.
- Motor/Blower is a self contained factory wired motorized impeller system designed for continuous operation.
- Separatorless type ULPA Filter is rated 99.9995% efficient at 0.12 microns.
- Intake Pre-filter is a medium efficient system rated 40% ASHRAE.
- Lighting is a fluorescent biax type, sealed in a clear P.V.C. shroud.
- Control panel houses ON/OFF switches for lights and motor/blower, static pressure monitor and airflow exhaust monitor.
- Polypropylene D.I. gooseneck faucet with remote operator.
- All welded natural polypropylene drop-in sink module with bottom drain.
- Integral vented polypropylene storage section complete with horizontal sliding access doors and one adjustable shelf.
- Electrical termination is either a cord with grounded plug, or an electrical termination box.



## Ultra-Clean Metal Free Systems

# VPFX SERIES TYPICAL SPECIFICATIONS

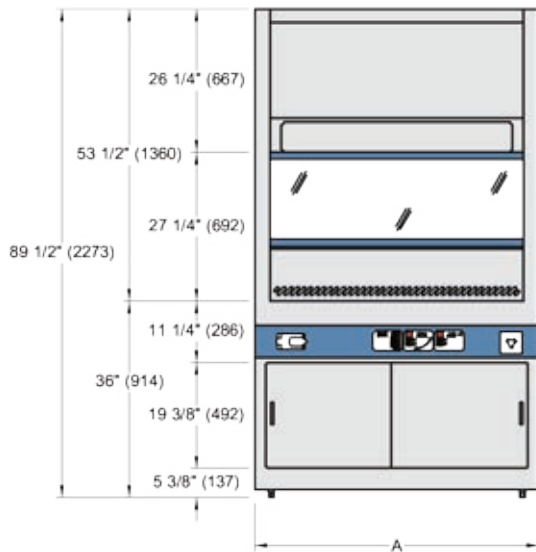

Front Elevation



Side View

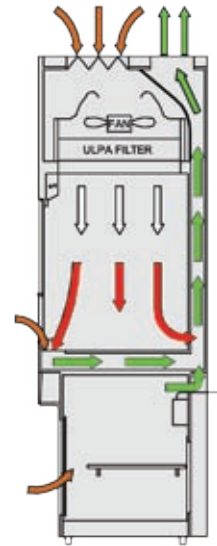

Air Flow





Model	Dim "A" (mm)	Work Surface (mm)	Hand Opening (mm)	ULPA Filter Size (mm)	Exhaust Collar (mm)	Hand Intake (90 FPM)	Base Vent	Air Supply (60 FPM)	Air Exhaust	Electrical Requirements	Shipping Weight
VPFX-4	52" (1,321)	43" x 22" (1,102 x 562)	46" x 8" (1,178 x 203)	24" x 48" (610 x 1,219)	8" (203)	290 CFM 490 M <sup>3</sup> /HR	40 CFM 68 M <sup>3</sup> /HR	510 CFM 866 M <sup>3</sup> /HR	840 CFM 1,427 M <sup>3</sup> /HR	115V, 4A, 60Hz	1,302 LBS 590 KG
VPFX-5	64" (1,626)	55" x 22" (1,406 x 562)	58" x 8" (1,483 x 203)	24" x 60" (610 x 1,524)	10" (250)	290 CFM 490 M <sup>3</sup> /HR	40 CFM 68 M <sup>3</sup> /HR	637 CFM 1,082 M <sup>3</sup> /HR	1,050 CFM 1,784 M <sup>3</sup> /HR	115V, 4A, 60Hz	1,576 LBS 715 KG
VPFX-6	76" (1,930)	67" x 22" (1,711 x 562)	70" x 8" (1,788 x 203)	24" x 72" (610 x 1,829)	10" (250)	290 CFM 490 M <sup>3</sup> /HR	40 CFM 68 M <sup>3</sup> /HR	765 CFM 1,300 M <sup>3</sup> /HR	1,260 CFM 2,141 M <sup>3</sup> /HR	115V, 4A, 60Hz	1,830 LBS 830 KG
VPFX-8	Consult Factory										

## Optional Accessories

Part No.	Description
CSR-2	Cascade rinser module with nitrogen agitation
GUN-DI	Teflon D.I. water spray gun with manual remote operation
GUN-N2	Teflon nitrogen spray gun with manual remote operation
EYE-1	Teflon hand held eye wash with manual local operation
ELEC-1	G.F.I. wired duplex electrical outlet located on front of base cabinet
ASP-1	Teflon aspirator with remote hand held wand assembly
RES-1	Resistivity monitoring system with remote sampling cell
T00106	Remote operated air, gas or vacuum turrets
WASH-1	Internal wash down manifold with manual remote operation

Note: Other options available, consult your factory representative.

## Air Flow Legend

-  Laboratory Air
-  Contaminated Work Chamber Air
-  Clean ULPA Filtered Air
-  Potentially Contaminated Work Chamber Air Mixed With Laboratory Air

# GENERAL DESCRIPTION

**Equipment:** Vertical Laminar Flow Fully Exhausted All Polypropylene Type

- Model:**
- VPFX - 4 Nominal 4ft. width
  - VPFX - 5 Nominal 5ft. width
  - VPFX - 6 Nominal 6ft. width
  - VPFX - 8 Nominal 8ft. width

**Description:** The Vertical Laminar Flow work station shall be a Micronzone Corporation Model VPFX. The interior construction shall be white polypropylene. The sectional work surface with integral perforated front air intake airfoil shall also be constructed from white polypropylene. The exterior panels shall be constructed from white polypropylene without exposed bolts or nuts. The exhaust plenum shall form an integral part of the unit and be constructed from white polypropylene. The exhaust plenum shall terminate in a duct collar connection flange. ULPA filters shall be industry standard size and a minimum of 99.9995% efficient on all 0.12m particles. The fluorescent lighting shall provide 80 to 100 foot-candles at the work surface and be sealed in a clear P.V.C. shroud. The recessed vertical sliding sash shall be clear P.V.C.. All cables and counterbalancing mechanisms shall be non-metal and located in a vertical front easy access service chase. A natural polypropylene integral drop-in sink module with bottom drain and a natural polypropylene D.I. water gooseneck faucet with remote operator shall be installed. Speed control shall be solid state and load rated for motor voltage and shall be set and adjusted electronically. Motor shall be a maintenance free, permanently lubricated ball bearing armature motor with single inlet centrifugal fan. There shall be an integrally vented polypropylene storage section complete with horizontal sliding access doors and a single adjustable shelf. All services to be factory plumbed and wired for single point field connection. The Vertical Laminar Flow Work Station mechanical operation shall be available in either a manual mode which offers standard ON/OFF switching for lights and motor and a minihelic visual pressure gauge monitoring the static pressure across the supply filter or in an electronic mode which features a Digital "DMC" soft start circuit motor control panel with an on/off feature for the blower, the light and the interior duplex outlet. Integral circuitry provides constant monitoring of voltage to the motor, current motor draw, voltage frequency and on-board diagnostics. In the event of a system fault, the system features flash codes on an LED display indicating the area of failure. Electronic "AFI-X2" airflow alarm gauge shall monitor system exhaust airflow. This system reports the static condition of the unit's exhaust airflow and provides both visual and audible alarms. The system detects problems with the building exhaust fan or increased static pressure. An electronic "SPM" pressure gauge shall continuously monitor the static pressure across the supply filter. This system reports the static condition of the integral filter systems (both visual and audible) with an alarm feature in the event of a drop in static pressure, motor failure or increased static pressure.



86 Harry Douglas Drive  
Ottawa, Ontario, Canada K2S 2C7  
Tel: (613) 831-8318  
Toll Free: (877) 252-7710  
Fax: (613) 831-8321  
E-Mail: [sales@microzone.com](mailto:sales@microzone.com)  
[www.microzone.com](http://www.microzone.com)

## Local Representative:

# ACID EXHAUST HOODS

## Horizontal Clean Air Type

Acid Hoods are generally used in lieu of standard fume hoods when ordinary laboratory air will contaminate samples and chemical reagents. The polypropylene lined work area is continually purged with HEPA (High Efficiency Particulate Air) filtered air, thereby providing an ultra clean working environment. There is no exposed metal downstream of the HEPA filter. The standard unit is factory wired and comes complete with many features.

### General Features

- Interior work volume constructed from white 1/2" polypropylene.
- Faceshield constructed from clear P.V.C.
- Motor/Blower is a self contained factory wired motorized impeller system designed for continuous operation.
- Separatorless type HEPA Filter is rated 99.99% efficient at 0.3 microns.
- Intake Pre-filter is a medium efficient system rated 40% ASHRAE.
- Lighting is a fluorescent biax type, sealed in a clear P.V.C. shroud.
- Control panel houses ON/OFF switches for lights and motor/blower, static pressure monitor and airflow exhaust monitor.
- Air, gas and vacuum turrets.
- All welded natural polypropylene drop-in sink module complete with bottom drain, polypropylene D.I. gooseneck faucet and remote operator.
- Electrical termination is either a cord with grounded plug, or an electrical termination box.

### Applications

- Low level chemical analysis.
- Trace metal analysis.
- Ultra-pure acid and chemical dispensing
- Environmental.



**STANDARD 6 FOOT MODEL**



**CUSTOM ACID EXHAUST HOOD**

# ACID EXHAUST HOODS AH SERIES TYPICAL SPECIFICATIONS

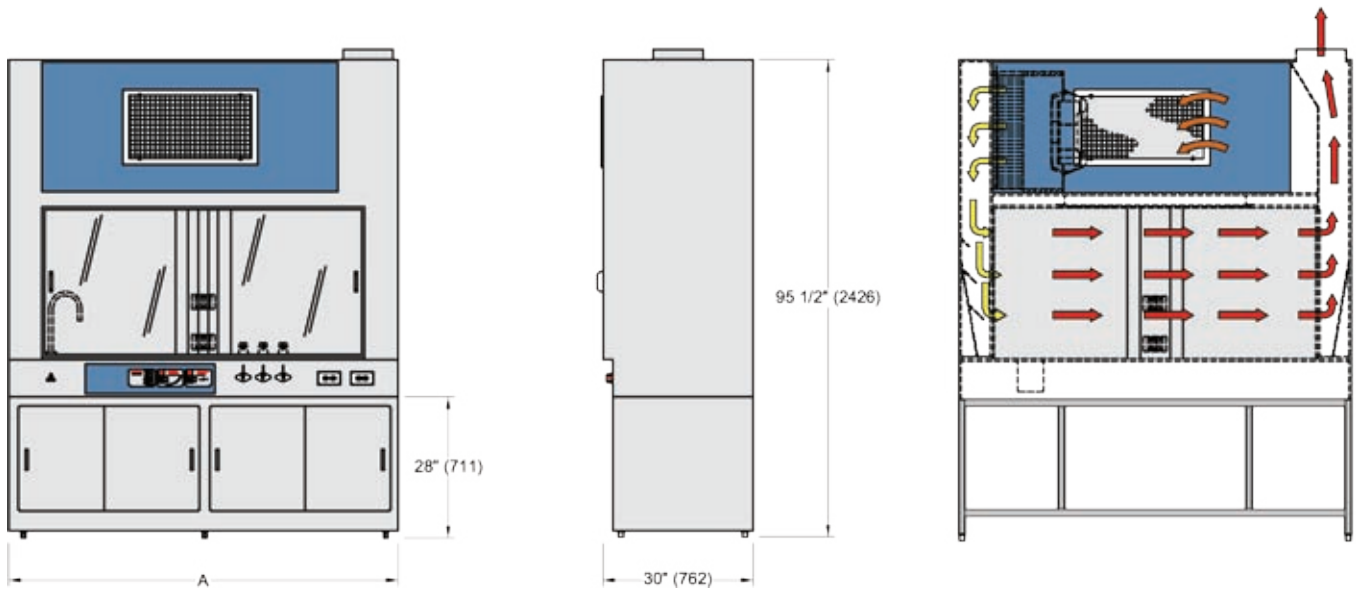

Model	Dim "A" (mm)	Work Surface (mm)	Hepa Filter Size (mm)	Exhaust Collar	Air Supply (60 FPM)	Air Exhaust	Electrical Requirements
AH-4-97	56" (1,422)	42" x 28" (1,067 x 711)	24" x 48" (610 x 1,219)	12" (305)	320 CFM 544 M <sup>3</sup> /HR	320 CFM 544 M <sup>3</sup> /HR	115V, 13A, 60Hz
AH-5-97	66" (1,676)	52" x 28" (1,321 x 711)	24" x 60" (610 x 1,524)	12" (305)	320 CFM 544 M <sup>3</sup> /HR	320 CFM 544 M <sup>3</sup> /HR	115V, 13A, 60Hz
AH-6-97	78" (1,981)	64" x 28" (1,626 x 711)	24" x 72" (610 x 1,829)	12" (305)	320 CFM 544 M <sup>3</sup> /HR	320 CFM 544 M <sup>3</sup> /HR	115V, 13A, 60Hz

**Air Flow Legend**

- Laboratory Air
- Contaminated Work Chamber Air
- Clean HEPA Filtered Air

Optional Accessories	
Part No.	Description
CSR-2	Cascade rinsing module with nitrogen agitation
GUN-DI	Teflon D.I. water spray gun with manual remote operation
GUN-N2	Teflon nitrogen spray gun with manual remote operation
EYE-1	Teflon hand held eye wash with manual local operation
ELEC-1	G.F.I. wired duplex electrical outlet located on front of base cabinet
ASP-1	Teflon aspirator with remote hand held wand assembly
RES-1	Resistivity monitoring system with remote sampling cell
T00106	Remote operated air, gas or vacuum turrets
WASH-1	Internal wash down manifold with manual remote operation

Note: Other options available, consult your factory representative.

Optional Accessories	
Part No.	Description
BF-48	Powder coated tube steel base support stand Nominal 4ft. wide
BF-60	Powder coated tube steel base support stand Nominal 5ft. wide
BF-72	Powder coated tube steel base support stand Nominal 6ft. wide
PP-BC-48	Polypropylene base support stand with sliding doors and adjustable shelves Nominal 4ft. wide
PP-BC-60	Polypropylene base support stand with sliding doors and adjustable shelves Nominal 5ft. wide
PP-BC-72	Polypropylene base support stand with sliding doors and adjustable shelves Nominal 6ft. wide

# GENERAL DESCRIPTION

**Equipment:** Acid Exhaust Hood - Horizontal Clean Air Type

- Model:**
- AH-4-97 Nominal 4ft. width
  - AH-5-97 Nominal 5ft. width
  - AH-6-97 Nominal 6ft. width

**Description:** The Horizontal Laminar Flow Acid Exhaust hood shall be a Micronzone Corporation Model AH. The interior construction shall be white polypropylene. The work surface shall also be constructed from white polypropylene. The exterior panels shall be constructed from white polypropylene without exposed bolts or nuts. The exhaust plenum shall form an integral part of the unit and be constructed from white polypropylene. The exhaust plenum shall terminate in a duct collar connection flange. HEPA filters shall be industry standard size and a minimum of 99.99% efficient on all 0.3m particles. The fluorescent lighting shall provide 80 to 100 foot-candles at the work surface and be sealed in a clear P.V.C. shroud. The recessed sliding sash shall be clear P.V.C. A natural polypropylene integral drop-in sink module with bottom drain and a natural polypropylene D.I. water gooseneck faucet with remote operator shall be installed. Speed control shall be solid state and load rated for motor voltage and shall be set and adjusted electronically. Motor shall be a maintenance free, permanently lubricated ball bearing armature motor with single inlet centrifugal fan. All services to be factory plumbed and wired for single point field connection. The Horizontal Laminar Flow Acid Hood mechanical operation shall be an electronic mode which features a Digital "DMC" soft start circuit motor control panel with on/off feature for the blower, the light and the interior duplex outlets. Integral circuitry provides constant monitoring of voltage to the motor, current motor draw, voltage frequency and on-board diagnostics. In the event of a system fault, the system features flash codes on an LED display indicating the area of failure. Electronic "AFI-X2" airflow alarm gauge shall monitor system exhaust airflow. This system reports the static condition of the unit's exhaust airflow and provides both visual and audible alarms. The system detects problems with the building exhaust fan or increased static pressure. An electronic "SPM" pressure gauge shall continuously monitor the static pressure across the supply filter. This system reports the static condition of the integral filter systems (both visual and audible) with an alarm feature in the event of a drop in static pressure, motor failure or increased static pressure. The standard services include: gas, air and vacuum turrets with local operation; two duplex outlet, a small pot sink and D.I. water gooseneck.



86 Harry Douglas Drive  
Ottawa, Ontario, Canada K2S 2C7  
Tel: (613) 831-8318  
Toll Free: (877) 252-7710  
Fax: (613) 831-8321  
E-Mail: [sales@microzone.com](mailto:sales@microzone.com)  
[www.microzone.com](http://www.microzone.com)

## Local Representative:



## Other Products

- **DOWNFLOW MODULES**



Polymer constructed Suspended Downflow modules can be used to generate a localized clean air environment exactly where you need it. The units are normally suspended from existing ceiling structures. Options include gauges to monitor the loading of the HEPA filters and anti-static curtains to provide maximum isolation. Downflow Modules are ideal for product isolation, weights/balance isolation and ICPMS ultra trace analysis enclosures.

- **BALANCED AIR & PERCHLORIC FUME HOODS**

We offer a wide range of standard sizes and options for our polymer constructed Fume Hoods. All units are factory assembled and pre-wired for easy site installation. Available in balanced air (ensures that a constant volume of the air exhausted from the laboratory regardless of the position of the face shield) or Perchloric Acid type which features integral rear wash down system and rear containment plenum. Consult factory for ordering information, available sizes and other options.



- **CHEMICAL HANDLING/STORAGE CABINETS**

We offer a wide range of standard sizes and options for our polymer constructed chemical cabinets. All units are factory assembled for easy site installation. Available in single or double door style with fixed or adjustable shelving. Consult factory for ordering information, available sizes and other options.



- **PLASTIC CASEWORK**



We offer a wide range of standard sizes and options for our polymer constructed casework cabinets. All units are factory assembled for easy site installation. Consult factory for ordering information, available sizes and other options.



86 Harry Douglas Drive  
Ottawa, Ontario, Canada K2S 2C7  
Tel: (613) 831-8318  
Toll Free: (877) 252-7710  
Fax: (613) 831-8321  
E-Mail: [sales@microzone.com](mailto:sales@microzone.com)  
[www.microzone.com](http://www.microzone.com)

### Local Representative: